



Mysteries: The Disappearing Neutrals in a TN-C-S Network

Date: 14 May 2026

[Watch Webinar Recording Here](#)

Emeritus Professor Akhtar Kalam

EIT EMERITUS PROFESSOR



About EIT

We are dedicated to ensuring that you receive a world-class education and gain skills that you can immediately implement in the workforce.



Engineering Specialists

EIT is one of the only institutes in the world specializing in Engineering. We deliver professional certificates, diplomas, advanced diplomas, undergraduate and graduate certificates, graduate diplomas, bachelor's and master's degrees, and a Doctorate of Engineering.



Industry Oriented Programs

Our programs are designed by industry experts, ensuring you graduate with cutting-edge skills that are valued by employers. Our program content remains current with rapidly changing technology and industry developments.



World-Class Australia Accredited Education

Our vocational programs and higher education degrees are registered and accredited by the Australian Government. We have programs that are also recognized under three international engineering accords.



Industry Experienced Lecturers

Our lecturers are highly experienced engineers and subject specialists with applied knowledge. The technologies employed by EIT, both online and on-campus, enable us to source our lecturers from a large, global pool of expertise.



Unique Delivery Model

We deliver our programs via a unique delivery methodology that makes use of live and interactive webinars, an international pool of expert lecturers, dedicated learning support officers, and state-of-the-art such as hands-on workshops, remote laboratories, and simulation software.



ECT delivers interactive and online **UK qualifications**. ECT is committed to providing students with a world-class education, where they acquire the knowledge and skills that are applicable and valued in industry.

- Bachelor of Engineering (Honours) in Industrial Automation
- Bachelor of Engineering (Honours) in Electrical Engineering
- Master of Science (Power System Analysis and Renewable Integration)
- Master of Science (Industrial Automation and Instrumentation Control)

Learn more [here](#).

Registered UK Higher Education Provider | UKPRN: 10089771



ECST delivers a **South African accredited qualification** on-campus. ECST is committed to providing students with a world-class education, where they acquire the knowledge and skills that are applicable and valued in industry.

- Bachelor of Engineering Technology in Electrical Engineering (SAQA 123645)

Learn more [here](#).

The Engineering College of Science and Technology (Pty) Ltd is provisionally registered with the Department of Higher Education and Training until 31/12/2028 as a private higher education institution under the Higher Education Act, 1997. Registration certificate no. 2025/HE07/007.

Disclaimer



The courses and qualifications mentioned in this presentation are offered by separate legal entities operating in different jurisdictions – one in Australia, one in South Africa and one in the United Kingdom. Each entity is subject to its own local regulatory requirements and accreditation standards.

Prospective students should refer to the relevant institution's official website for accurate, up-to-date information specific to their location, including course availability, fees, regulatory status, and enrolment conditions.

- For the Engineering Institute of Technology (EIT) visit: <https://www.eit.edu.au/>
- For the Engineering College of Technology (ECT) visit: <https://www.ect.ac.uk/>
- For the Engineering College of Science and Technology (ECST) visit: <https://www.ecst.ac.za/>

Event Conduct



Please keep discussion lawful and respectful; follow the moderator's directions.
Do not share illegal or abusive content. Recording is not permitted unless authorised.
Breaches may lead to removal.

Introduction – Presenter



Emeritus Professor Akhtar Kalam

Emeritus Professor at Victoria University and EIT.

Academic Director and Chair of the Academic Board - Texila College Australia.

Director of Al-Kalam Educational Solutions.

Editor-in-Chief of AJEEE

Distinguished Professor/Adjunct Faculty in Australia, India, Malaysia and Oman.

He has published over 610 publications in his area of expertise and has written over 29 books.

Supervised 51 postgraduate research students to graduation, including 39 PhD's and 12 MEngs. Currently, 10 postgraduate research students (four PhD students at VU and six DEng students at EIT) are being supervised.

Public, University, and Motivational Lecturer.

Consultant for the electricity supply industries in Australia and overseas.

Assisted in change management plans for Universities and the higher education sector.

Education

The University of Bath, Bath, UK, D.Eng., Electrical Engineering

The University of Oklahoma, Norman, USA, MS, Electrical Engineering

Aligarh Muslim University, Aligarh, India, BSc. Eng., Electrical Engineering

St Xavier's College, Calcutta, India, Applied Science

Professional Society Activities

Australian Institute of Energy – Fellow

Engineers Australia – Fellow

The Institution of Engineers and Technology, UK – Fellow.

The Institution of Electrical and Electronic Engineers, USA –Life Senior Member.

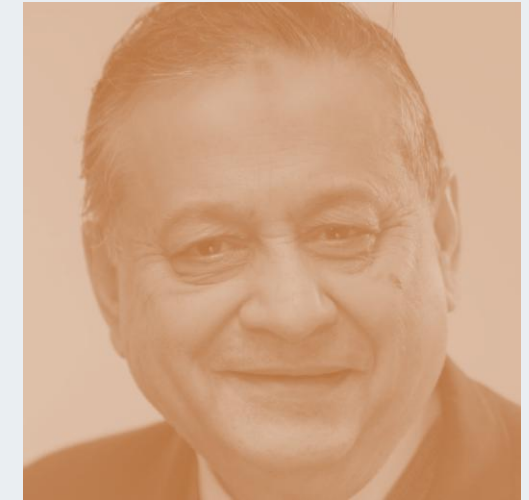

“My vision is to provide exciting higher education science and engineering courses, research, consultancy and collaborate in development work of the industry and communities within Australia and beyond.”

Agenda

	Overview
	Learning Objectives
	The Mystery
	Analytical Illustration
	Symptoms seen by the engineer
	Prevention Strategies
	Discussions and Q&A



Electrical Earthing System

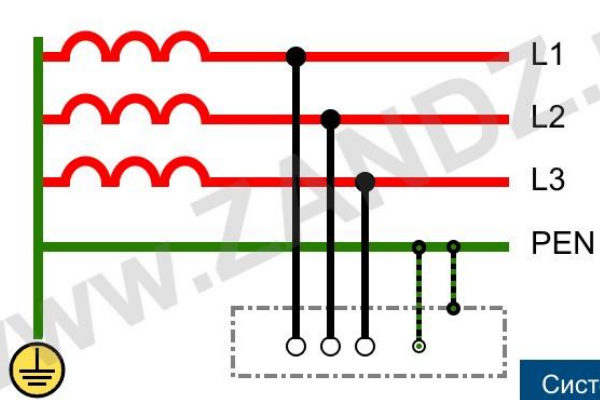

Система TN-C

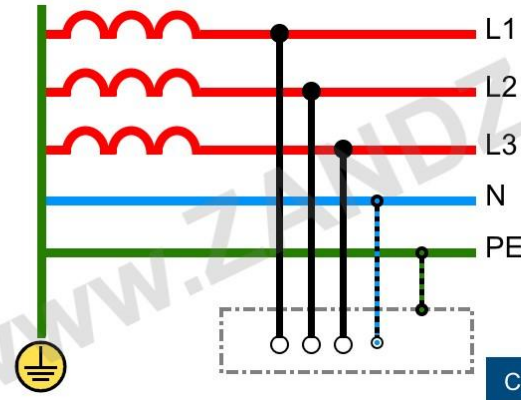

Система TN-S

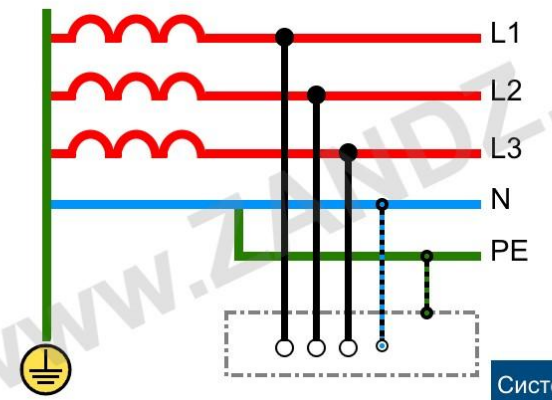

Система TN-C-S

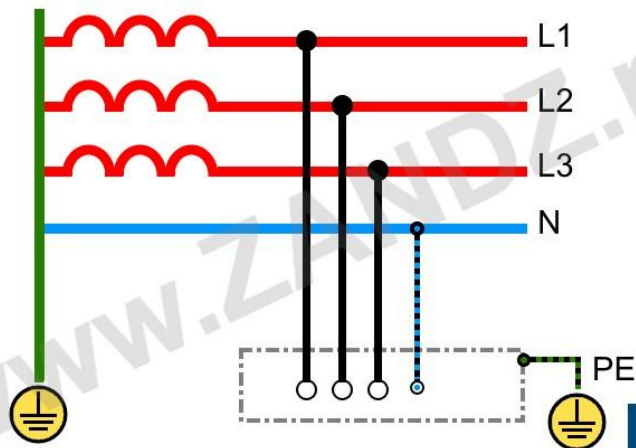

Система TT

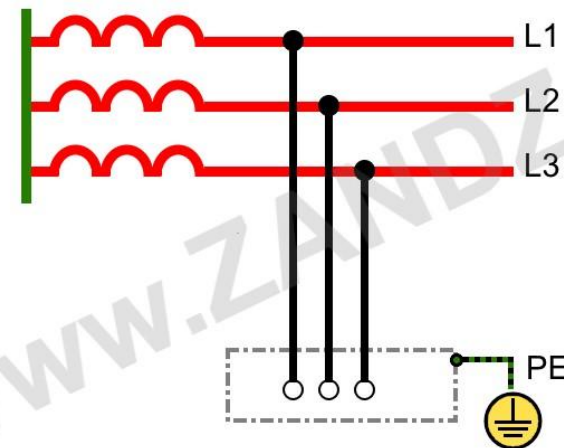

Система IT

Learning Objectives

By the end of this session, you should be able to:

- Explain the structure of a TN-C-S earthing system
- Understand the function of the neutral conductor
- Identify causes of neutral failure
- Analyse voltage imbalance due to open neutral faults
- Diagnose symptoms in field installations
- Recommend protection and mitigation strategies

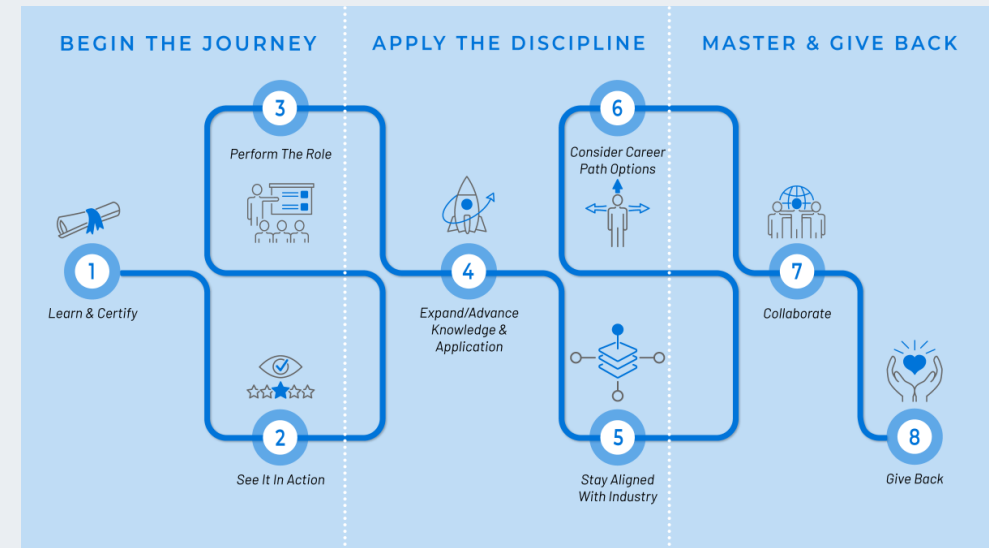

The Mystery Begins

The Field Complaint

Customer Reports:

- Lights unusually bright in one room
- The lights dim in another
- TVs and computers are repeatedly failing
- Electric shocks from metallic appliances
- Burning smell from the switchboard
- Neutral voltage reading “strange”



First Engineering Assumptions

Possible causes considered:

- Transformer fault
- Phase imbalance
- Harmonic distortion
- Faulty RCDs
- Poor earthing
- Loose neutral connection

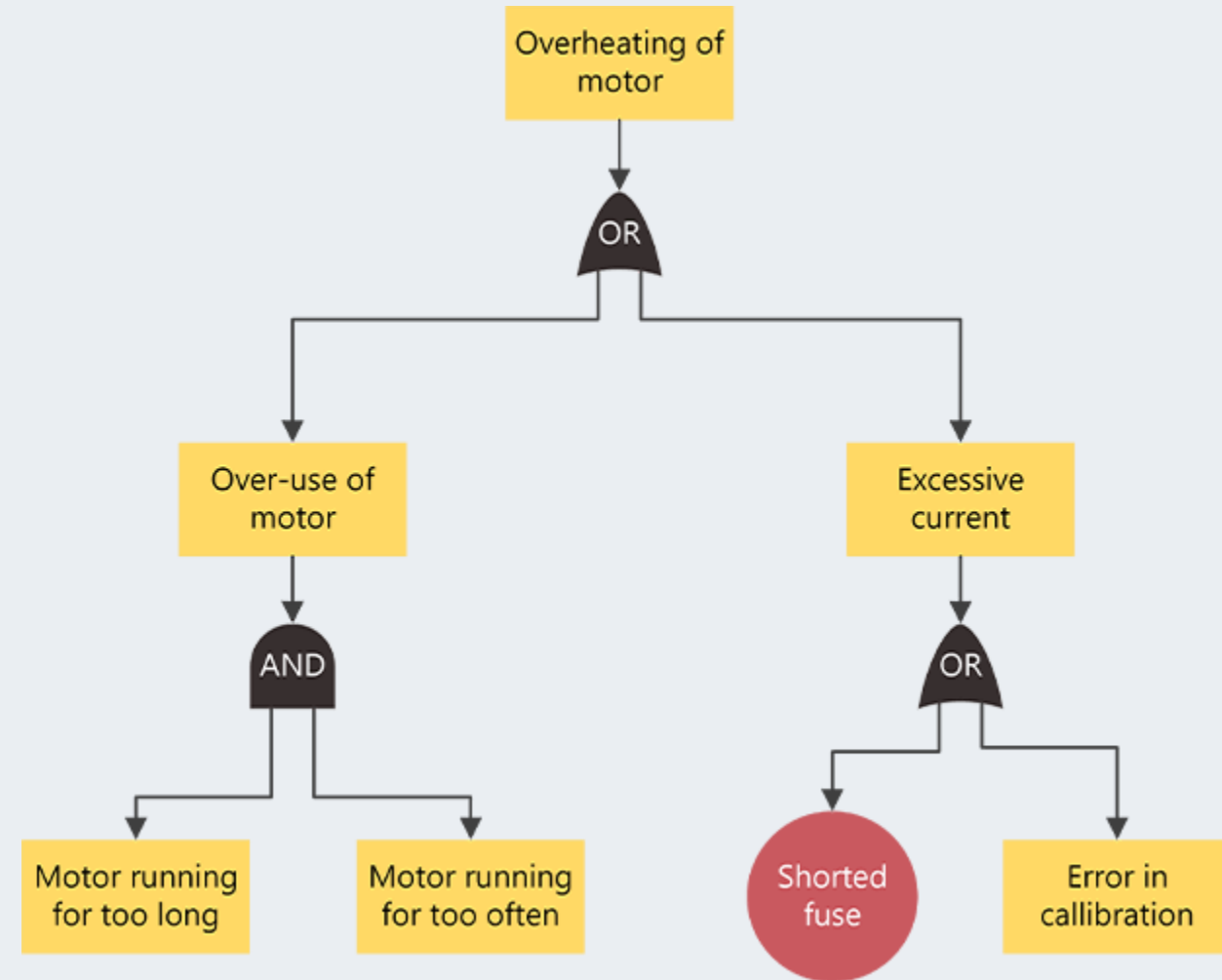

What is a TN-C-S System?

TN-C-S Earthing System

Definition:

- The transformer neutral is earthed
- Neutral and protective earth combined as a PEN conductor upstream
- Split into separate PE and N conductors downstream

Also Known As:

Protective Multiple Earthing (PME)

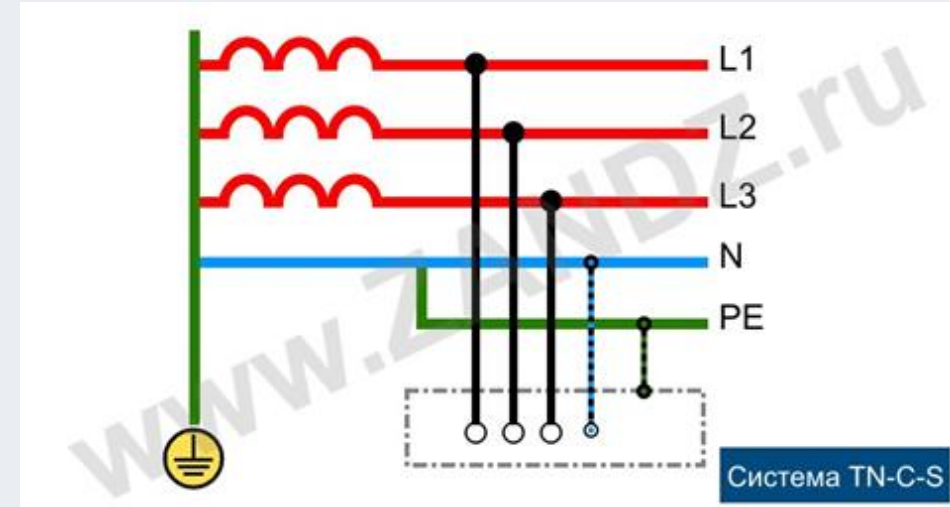

Why the Neutral Matters?

Functions:

- Return path for unbalanced current
- Voltage reference point
- Stabilises phase-to-neutral voltages
- Safety reference for protective devices

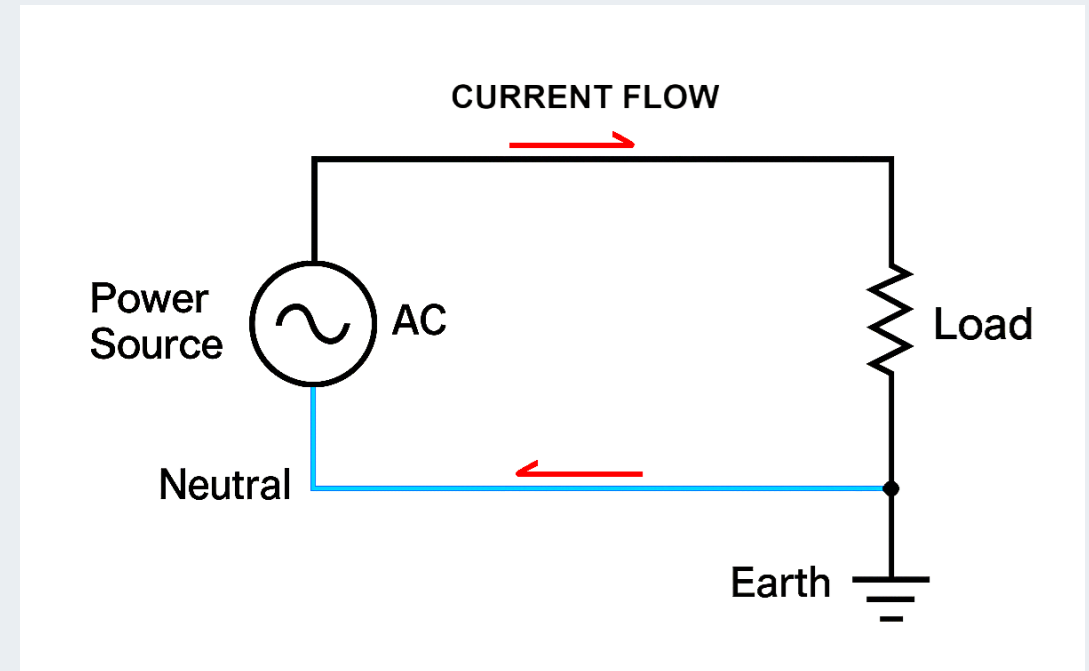

Without Neutral:

System behaviour becomes unpredictable

Balanced vs Unbalanced Loads

Perfectly Balanced System:

Neutral current = zero

Real Installations:

- Single-phase loads vary
- Domestic appliances switch randomly
- Commercial systems are heavily unbalanced

Result:

A neutral conductor continuously carries current

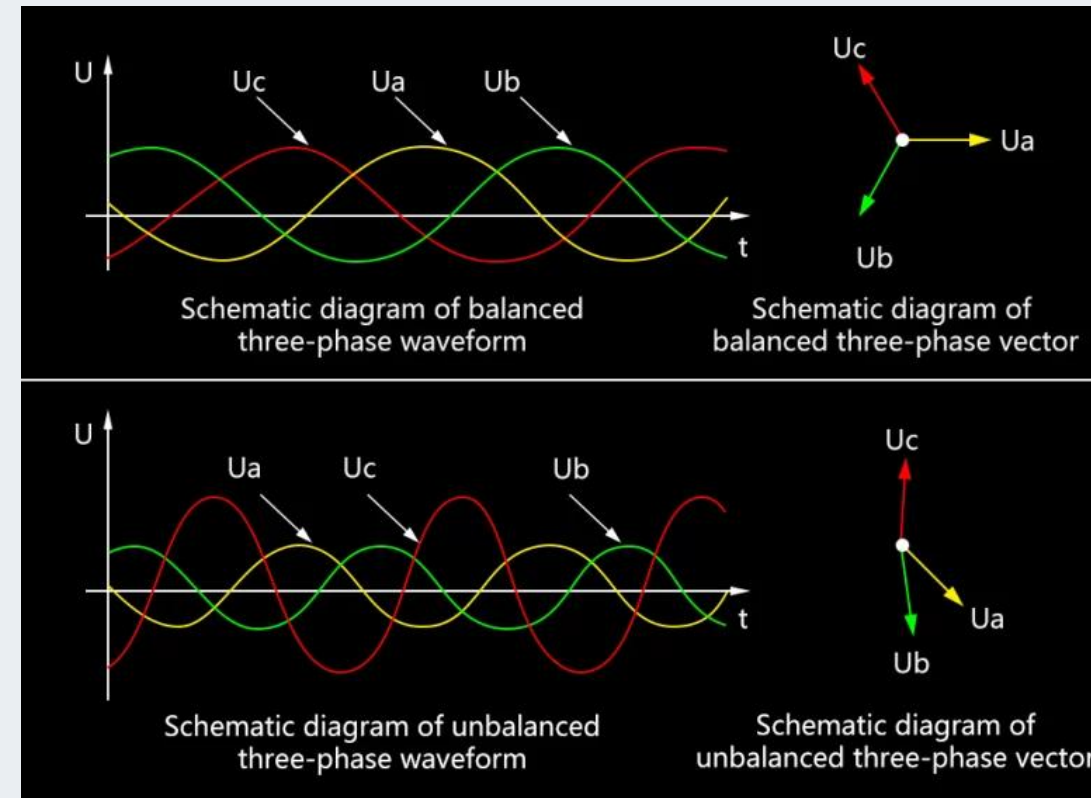

Where the Neutral “Disappears”

Common Failure Locations

- Service head connection
- Overhead service line
- Underground cable joint
- Main switchboard terminal
- Metering enclosure
- Utility-side PEN conductor

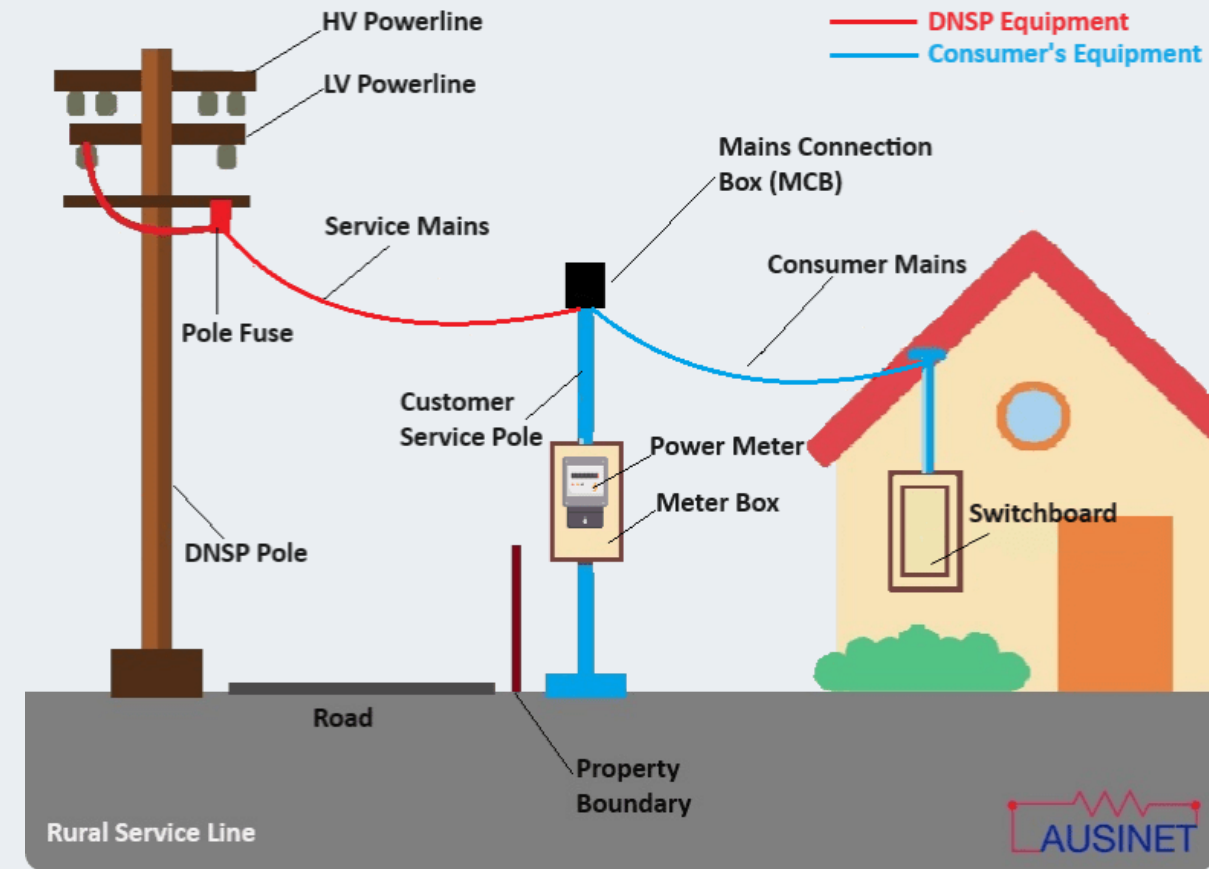

The Open Neutral Event

What Happens When Neutral Opens?

Immediate Effects:

- Neutral reference shifts
- Load voltages redistribute
- Some loads receive overvoltage
- Some loads receive undervoltage

Result:

Silent destruction begins

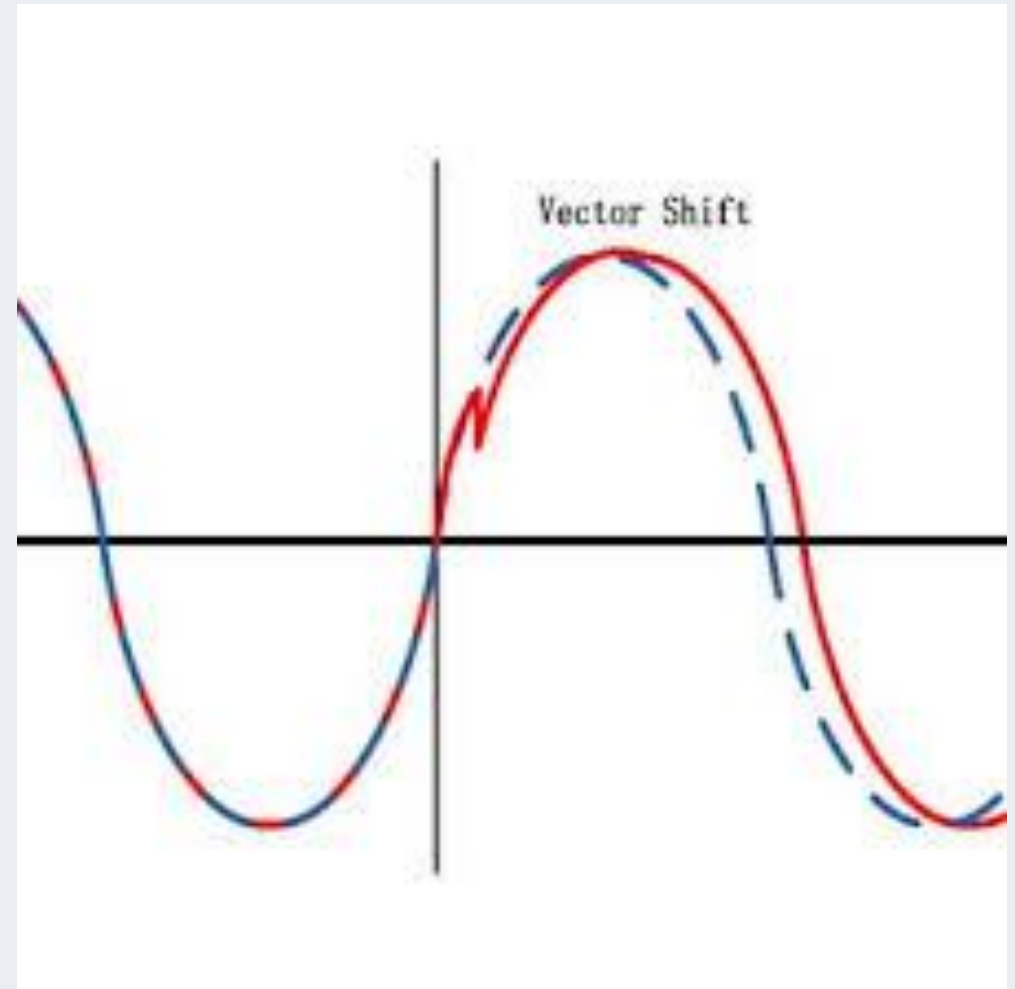

Floating Neutral Explained

Floating Neutral Concept

Instead of:

Stable 230 V phase-neutral

You Get:

Voltage division based on load resistance

Example:

- One load may see 320 V
- Another may see 90 V

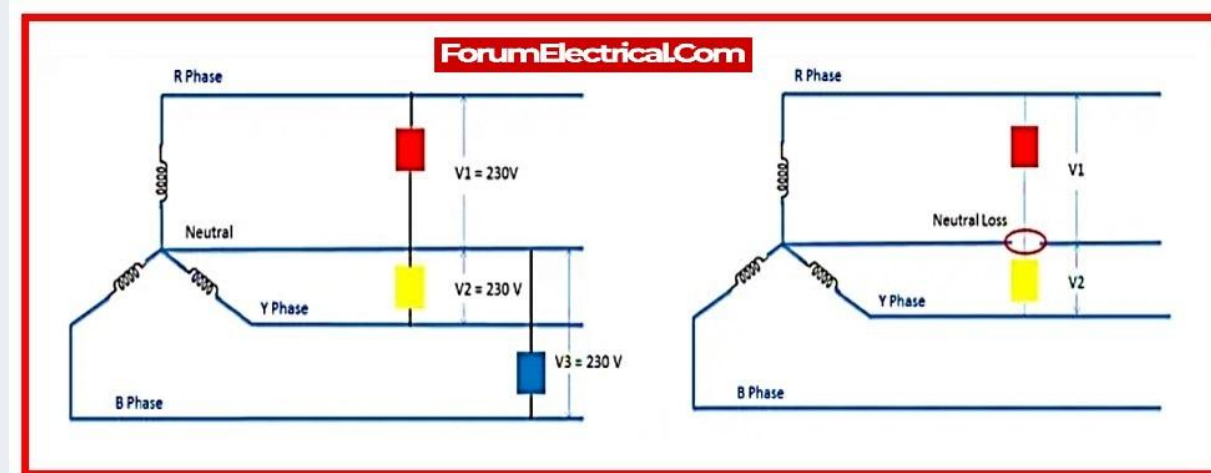

Mathematical Illustration

Voltage Redistribution

In a typical 120/240V residential split-phase system, two loads (R1 and R2) usually connect to a common neutral break and become series-connected across the 240V L₁-L₂ voltage.

SPLIT-PHASE 120/240 V SYSTEM – FLOATING NEUTRAL PRINCIPLE

1. NORMAL OPERATION – NEUTRAL INTACT

Neutral is solidly connected (0 V reference). Each load receives 120 V.

Utility Transformer (Split-Phase)
Primary (High Voltage)

L1
120 V
N (Neutral)
120 V
L2

R₁ (Load 1)
R₂ (Load 2)

Voltages:
V_{L1-N} = 120 V
V_{L2-N} = 120 V
V_{L1-L2} = 240 V

Neutral is fixed at 0 V.
Loads operate normally.

2. FAULT CONDITION – NEUTRAL OPEN (FLOATING)

Neutral is open. The loads become series-connected across 240 V.

L1
240 V
N (Floating)
L2

R₁ (Load 1)
R₂ (Load 2)

Total across L1-L2 = 240 V

Circuit current:
 $I = \frac{240}{R_1 + R_2}$

Voltages:
 $V_1 = IR_1 = \frac{240R_1}{R_1 + R_2}$
 $V_2 = IR_2 = \frac{240R_2}{R_1 + R_2}$

Neutral voltage (w.r.t. L2):
 $V_N = V_2 = \frac{240R_2}{R_1 + R_2}$

3. VOLTAGE DIVISION AT THE FLOATING NEUTRAL

L1 (+120 V reference)
240 V
L2 (-120 V reference)

R₁ (Load 1)
R₂ (Load 2)
N (Floating)

Voltage Division:
 $V_1 = \frac{240R_1}{R_1 + R_2}$
 $V_2 = \frac{240R_2}{R_1 + R_2}$
 $V_1 + V_2 = 240 V$

Key Principle (Floating Point):
The neutral point is not fixed. It "floats" to a voltage determined by the ratio of the load resistances.

- Higher resistance ⇒ higher voltage
- Lower resistance ⇒ lower voltage
- Equal resistances ⇒ 120 V each

4. EXAMPLES

Case	R ₁ (Ω)	R ₂ (Ω)	V ₁ (V)	V ₂ (V)	V _N (w.r.t. L2)
1. Balanced Loads	20	20	120	120	120 V
2. R ₁ > R ₂	20	5	192	48	48 V
3. R ₁ < R ₂	5	20	48	192	192 V

Why It Is Dangerous:

- Appliances designed for 120 V may receive severe overvoltage or undervoltage.
- Overvoltage ⇒ insulation failure, burnout.
- Undervoltage ⇒ motor stalling, overheating.
- The neutral is no longer a reference point; it becomes a dependent (floating) node.

Important Notes:

- This analysis assumes purely resistive loads.
- With reactive or non-linear loads, voltages and currents are more complex, but the floating principle still applies.
- Always ensure a solid neutral connection in 120/240 V systems.

Legend:

L1 : Line 1 (Hot)

L2 : Line 2 (Hot)

N : Neutral

⊥ : Ground

Example Case

Real Example

Two Loads:

- Heater: low impedance
- LED TV: high impedance

Result:

- The heater gets low voltage
- TV gets severe overvoltage

Outcome:

TV destroyed, heater survives



Why RCDs May Not Trip

Protection Failure Surprise

RCDs detect:

Residual imbalance

Open Neutral causes:

Voltage shift—not necessarily leakage current

Result:

- No trip, but a dangerous condition persists

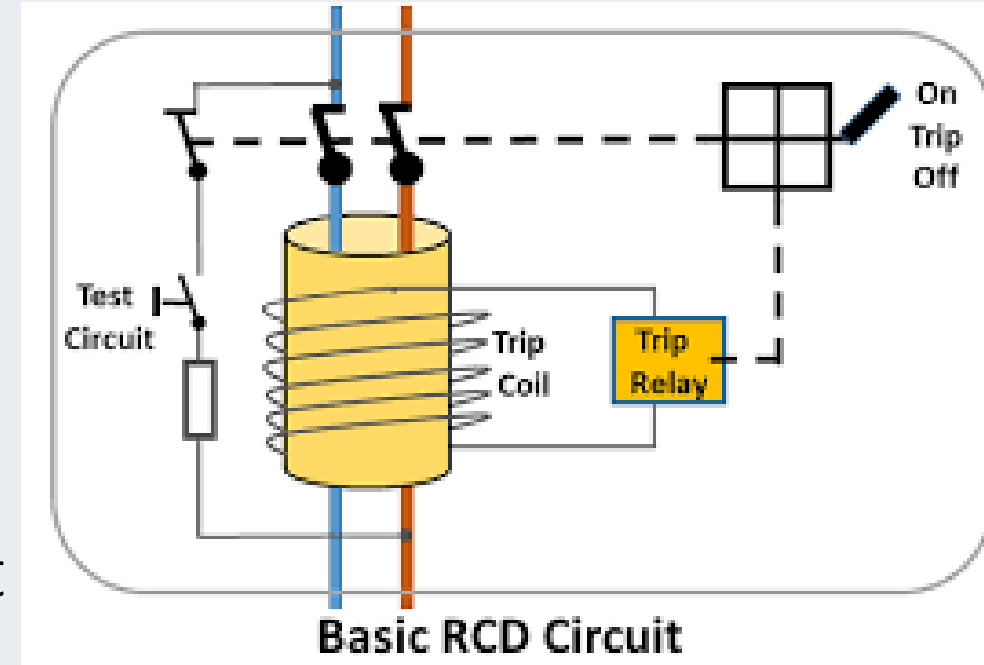

Earth Potential Rise

Shock Hazard Increases

Because:

The PEN conductor also carries protective earth function

Failure causes:

Metal enclosures rise above the earth's potential

Result:

- Touch voltage hazard

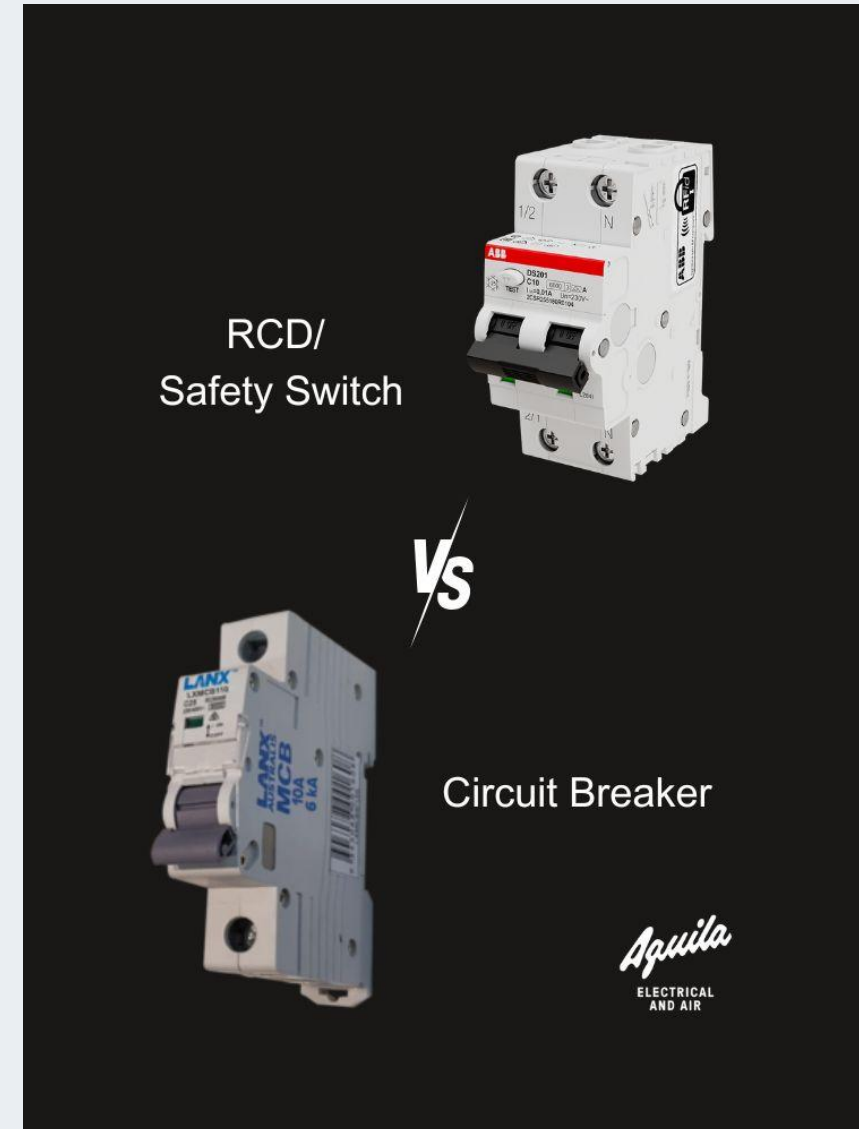

Symptoms Seen by Engineers

Practical Warning Signs

- Flickering lights
- Lamps unusually bright
- Repeated electronic failures
- Warm neutral terminals
- Voltage instability
- Tingling sensation in appliances
- Burnt smell from panels



Investigation Tools

Diagnostic Equipment

- True RMS multimeter
- Clamp meter
- Thermal camera
- Power quality analyser
- Earth loop impedance tester
- Visual inspection



Voltage Measurements

What Engineers Observe

Normal:

230 V \pm tolerance

Fault Condition:

- 80 V on one circuit
- 310 V on another
- Neutral-earth voltage abnormal



Neutral-to-Earth Voltage

A Critical Clue

Healthy System:

Very low N-E voltage

Faulted System:

Elevated N-E voltage

Why?

Neutral is no longer stable

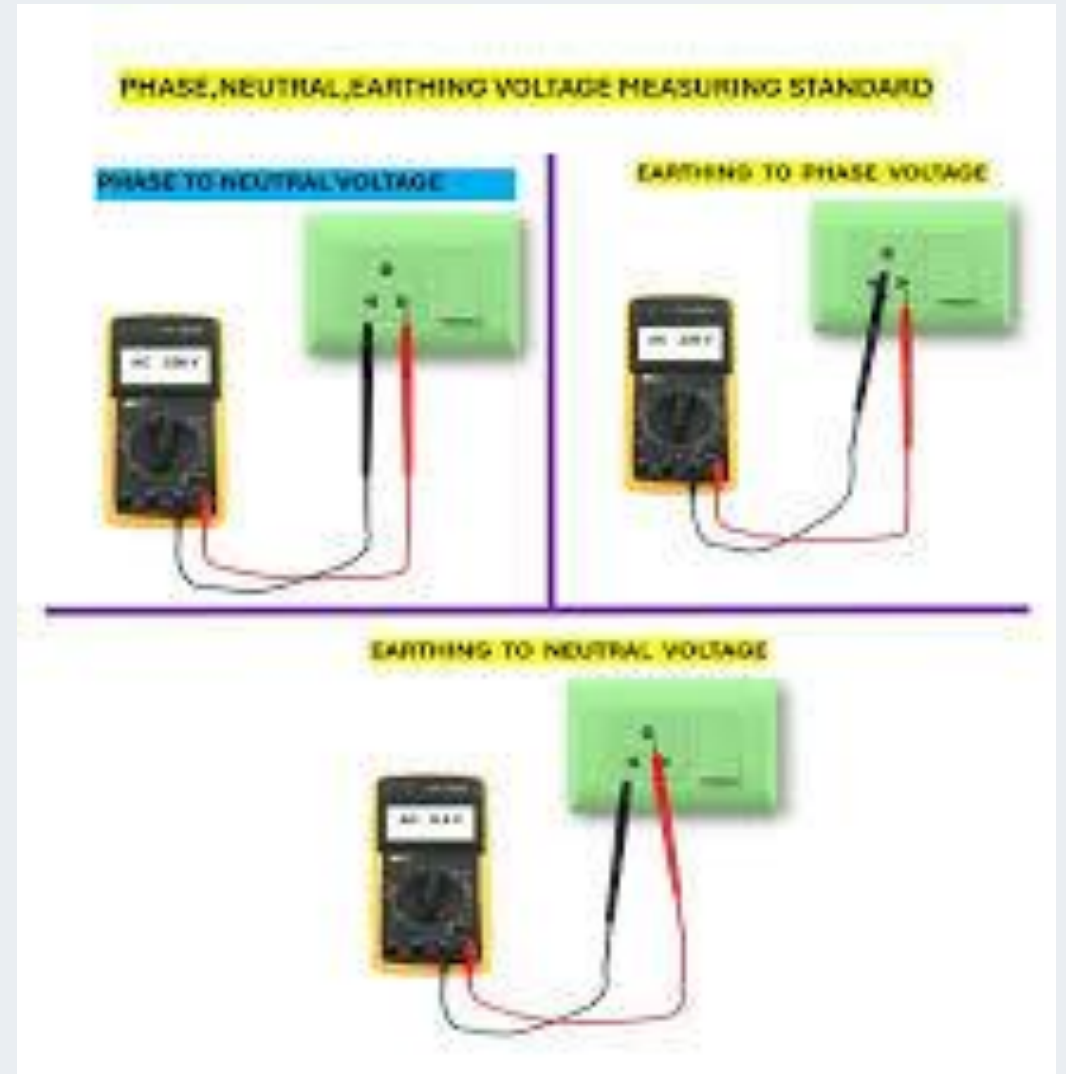

Thermal Evidence

Heat Never Lies

Loose Neutral Causes:

- Resistance increase
- I^2R heating
- Terminal discoloration
- Insulation damage

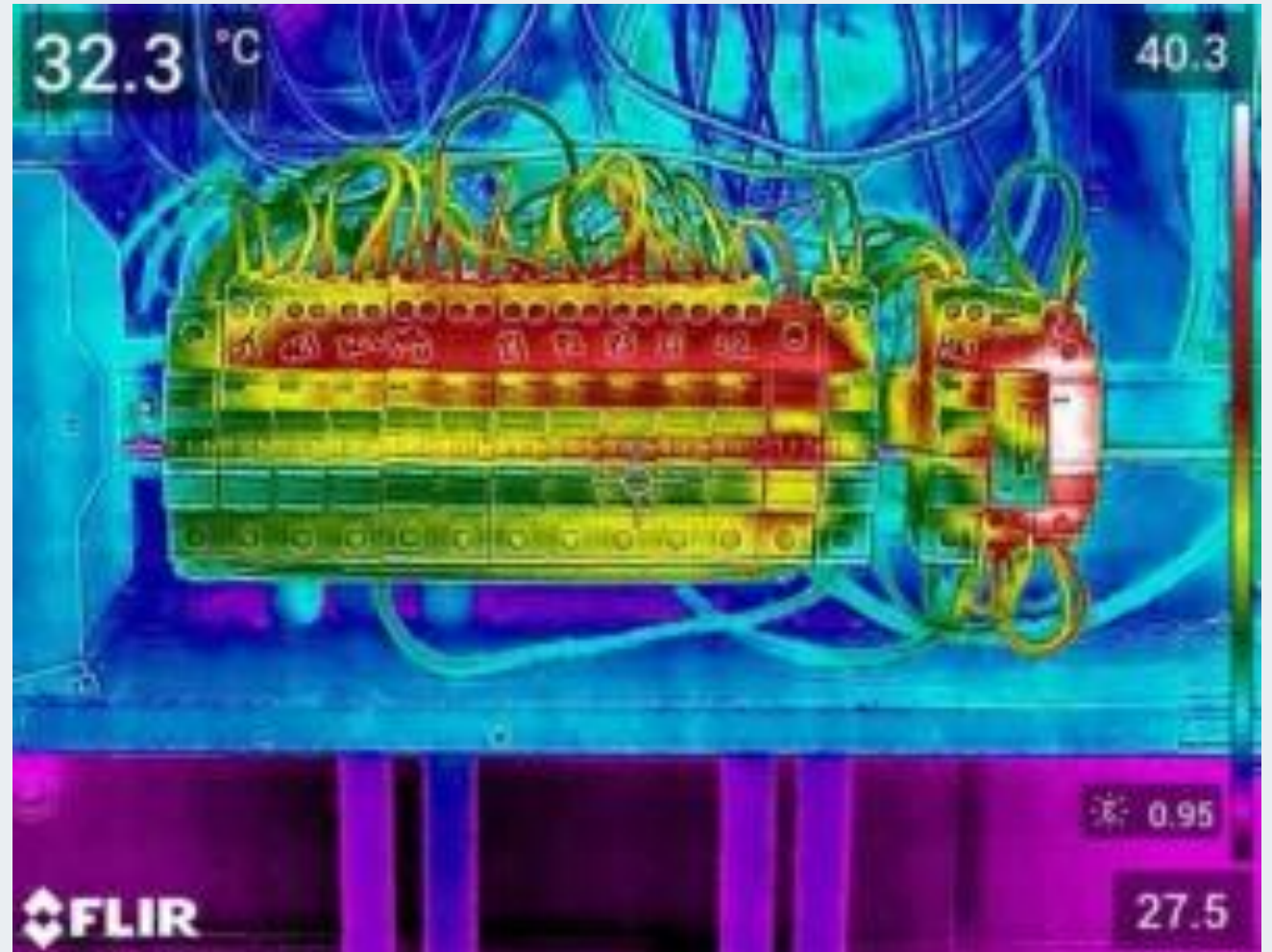

Utility vs Customer Side

Whose Fault Is It?

Possible responsibility:

- Utility supply neutral fault
- Consumer's main neutral failure
- Metering contractor issue
- Switchboard installation defect

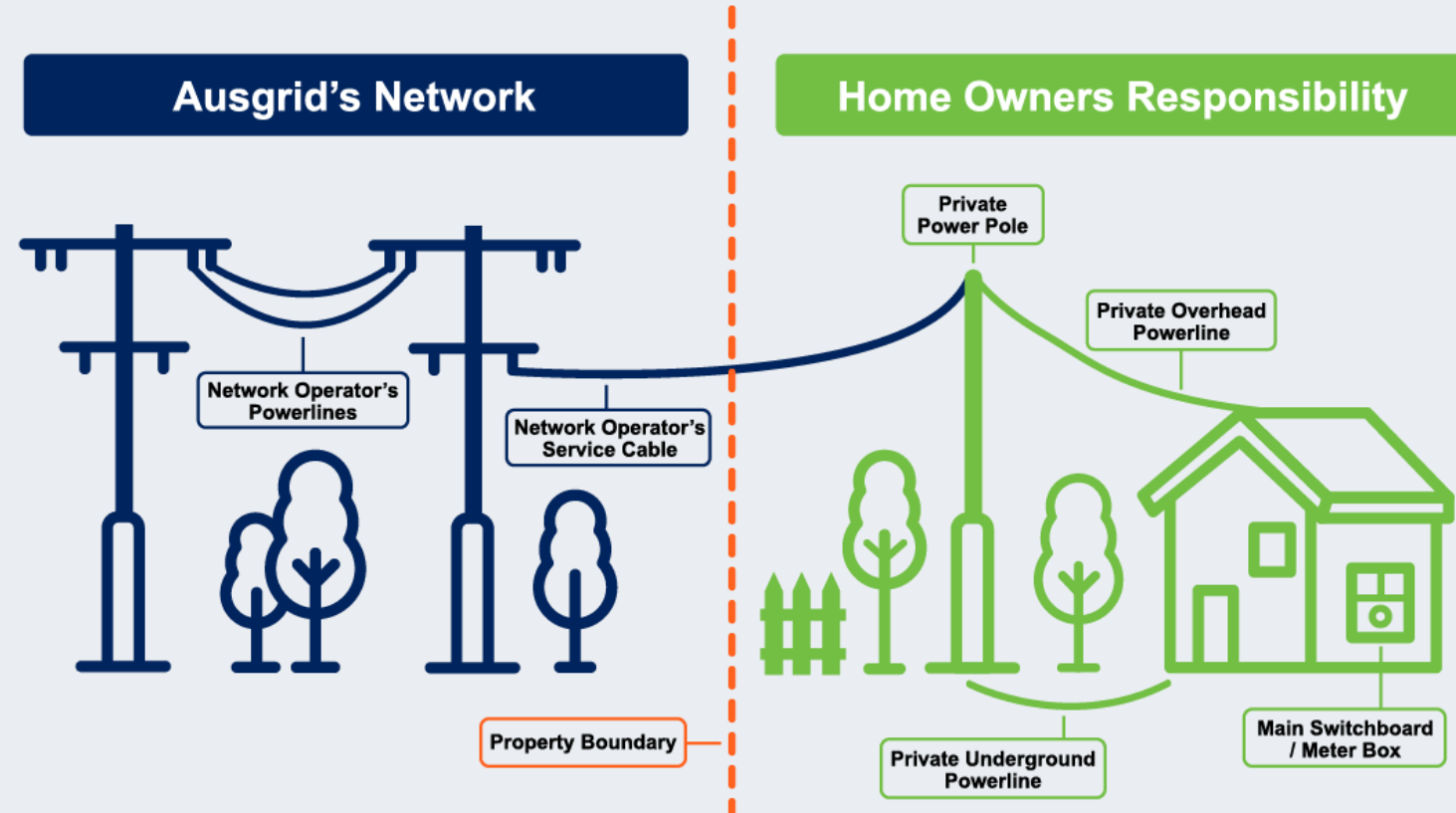

Prevention Strategies

Engineering Controls

- Proper torque on terminals
- Periodic thermal inspections
- Quality cable joints
- PEN conductor integrity checks
- Neutral monitoring relays
- Correct bonding practices

FREE

ELECTRICAL PREVENTIVE MAINTENANCE SCHEDULE TEMPLATE

Structured plan for systematic electrical maintenance scheduling, ensuring equipment reliability and safety.



ELECTRICAL PREVENTIVE MAINTENANCE SCHEDULE			
Department Details			
Department Name:	Electrical Maintenance Department		
Organization:	KV2 Technology		
Contact Information:			
Phone:	+1 (555) 123-4567		
Email:	info@kv2techsupport.com		
Address:	123 Main Street, Cityville, State, Zip Code		
Critical Tasks	Frequency	Status	Date Completed
Check main panels	SA	Completed	3-Nov-2023
Check panel cooling fan & clean its filter	SSH	Completed	3-Nov-2023
Clean main pump inverter & its cooling fan	M	Completed	3-Nov-2023
Check all circuit breaker, magnetic	M	Completed	3-Nov-2023
Check current setting of all circuit breaker	M	Completed	3-Nov-2023
Visual checking of all power & control	W	Completed	3-Nov-2023
Check all motor's terminals	A	Completed	4-Nov-2023
Check & clean fluff & dirt at all motor fan	Q	Completed	4-Nov-2023
Drive of knee motors	SST	Completed	4-Nov-2023
Check all pressure switches	SSH	Completed	4-Nov-2023
Check calibration of main vessel & all addition tank	Q	Completed	4-Nov-2023
Check all signal isolators	SST	Completed	5-Nov-2023
Check setting & operation of lid safety switches	SSH	Pending	6-Nov-2023
Check setting of tangle sensors	Q	Pending	8-Nov-2023
Check all pneumatic solenoids	W	Pending	10-Nov-2023
Check all indicating lamps	W	Pending	12-Nov-2023
Check calibration of heating/cooling modulating valve	A	Completed	14-Nov-2023
Check all on/off switches	M	Completed	16-Nov-2023

Smart Protection Options

Advanced Solutions

- Neutral failure detection relays
- Voltage monitoring relays
- Smart metering alarms
- Continuous PQ monitoring
- Remote diagnostics



Relevant Standards

Standards and Compliance

Examples:

- AS/NZS 3000 Wiring Rules
- IEC 60364
- Utility service rules
- Earthing and bonding standards

Focus Areas:

- Neutral integrity
- Earthing continuity
- MEN connections

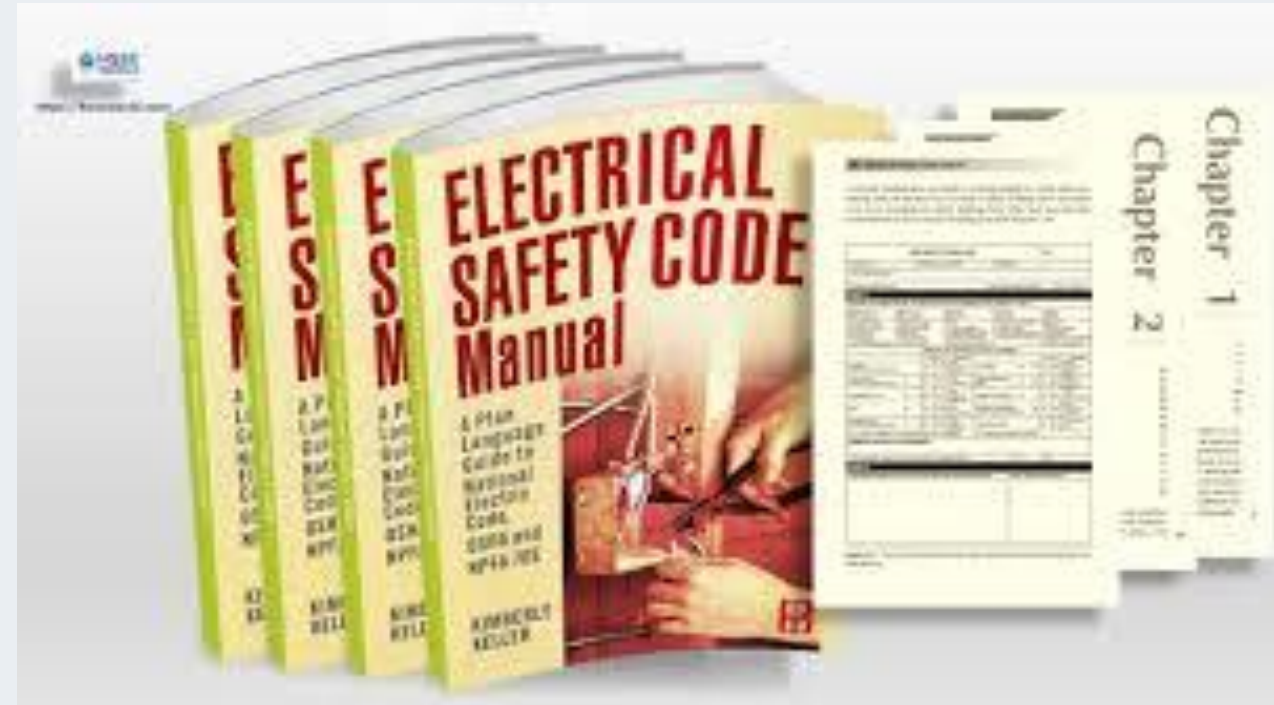

Lessons Learned

Engineering Lessons

- Never underestimate neutral conductors
- Voltage imbalance often points to neutral issues
- Protective devices may not save the system
- Thermal evidence is invaluable
- TN-C-S requires disciplined maintenance



Discussion Question

Critical Thinking

Question:

Critical Thinking

Question:

Would converting from TN-C-S to the TT system eliminate this risk?

Why or why not?

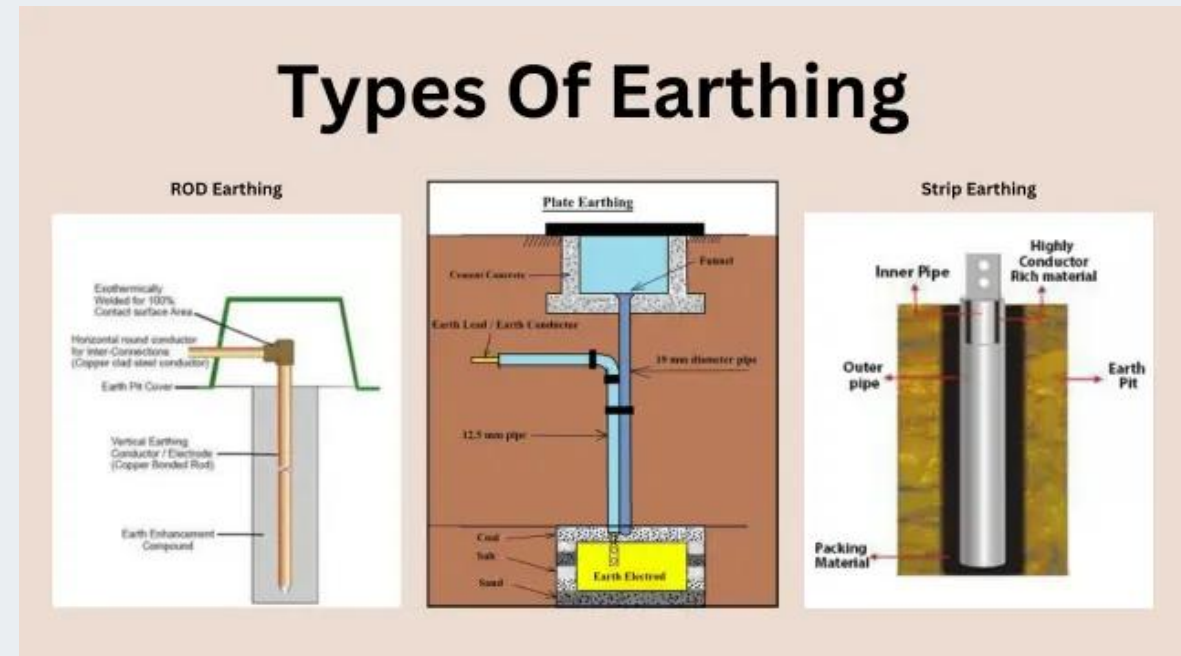

Final Takeaway

Final Message

“A missing neutral is not a minor fault—it is a system-wide emergency.”

Engineers must:

- Recognize it fast
- Diagnose it correctly
- Isolate it safely
- Prevent recurrence



Upcoming Mysteries Webinars



Register now!

21 May - Why the UPS Failed During a Blackout But Passed All Tests?

11 June – Cable That Melted at 60% Load

18 June - The Phantom Neutral - Why the Feeder Voltage Floated Overnight?

9 July – The Relay That Refused to See a Short

16 July - The Capacitor Bank That Blew Itself Up Quietly

13 August – The Motor That Wouldn't Start - Unless It Was Empty

20 August - The Neon Sign That Pulsed with Passing Trucks

10 September – The Battery Bank That Lost Capacity Overnight

17 September - The Streetlight That Kept Turning on at Noon

12 November – The Transformer That Changed Tap Position by Itself

19 November – The Circuit That Lost Half Its Phase Over the Years

10 December – The PLC That Spoke Back - A Control Loop with a Mind of Its Own

17 December - The Resonant Substation - Lights Flicker Without Load Change

27 January - The Induced Voltage That Woke the Cattle

Q&A



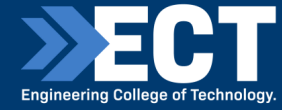

Thank You!

Upcoming Courses



Please note: courses listed below are subject to their own regulatory requirements—refer to the relevant website for further information.

Engineering Institute of Technology (EIT) <i>Australian Accredited Qualifications & Short Courses</i>	Start Date
52931WA Advanced Diploma of Illumination Engineering and Lighting Design	2 June 2026
UET60222 Advanced Diploma of ESI - Power Systems (Australia and New Zealand Only)	2 June 2026
Professional Certificate of Competency in Power Distribution	9 June 2026
Professional Certificate of Competency in Green Smelting Technologies	9 June 2026
Master of Engineering (Electrical Systems)	29 June 2026
Graduate Certificate in Power System Analysis and Design	29 June 2026
Graduate Certificate in Power Engineering	29 June 2026
Graduate Diploma of Engineering (Electrical Systems)	29 June 2026
Master of Engineering - Applied Research (Electrical Systems)	29 June 2026
52894WA Advanced Diploma of Applied Electrical Engineering (Renewable Energy)	7 July 2026
Bachelor of Science (Electrical Engineering)	20 July 2026

Upcoming Courses



Please note: courses listed below are offered by separate institutions in the UK and South Africa, each subject to their own regulatory requirements - refer to the relevant website for location-specific details.

Engineering College of Technology (ECT) <i>UK qualifications</i>	Start Date
Master of Science (Power System Analysis and Renewable Integration)	1 June 2026
Master of Science (Industrial Automation and Instrumentation Control)	1 June 2026
Bachelor of Engineering (Honours) in Electrical Engineering	21 September 2026
Bachelor of Engineering (Honours) in Industrial Automation	21 September 2026

Engineering College of Science and Technology (ECST) <i>South African accredited qualification & ECSA-endorsed</i>	Start Date
Bachelor of Engineering Technology in Electrical Engineering	3 August 2026

Contact Us:



Website

www.eit.edu.au



Head Office

6 & 8 Thelma Street, West Perth,
Perth, WA 6005



Phone

Inside Australia: 1300 138 522
Outside Australia: +61 8 9321 1702



Email

webinars@eit.edu.au



Courses

<https://www.eit.edu.au/schedule/>



Website

www.ect.ac.uk



Head Office

Whittle Way, Stevenage SG1 2FS,
United Kingdom



Phone

Inside UK: 0208 335 4014
Outside UK: +44 208 335 4014



Programmes

<https://www.ect.ac.uk/programmes/>



Website

www.ecst.ac.za



Head Office

Unit 3, Elevation Gardens,
Elevation Close, Waterfall
Office Park, Midrand, 1686



Phone

Within South Africa: 010 823 4497
Outside South Africa: +27 11 823 4497



Programmes

[www.ecst.ac.za/course-
types/bachelor-of-engineering/](http://www.ecst.ac.za/course-types/bachelor-of-engineering/)